

Steeple Data

Base Width: 88"
 Steeple Height: 34'-0"
 Weight: 1500 lb.
 Three-piece Steeple unit

Available Options:

- 3' or 4' Aluminum Cross
- 8" Ball
- Lightning Protection
- Round Top Simulated Louvers
- Krinkleglass Windows
- Various accessories available for Spire and Base

ALL STEEPLES MUST BE MOUNTED ON A COMPLETED WATERPROOF ROOF SYSTEM AS LONG-TERM INSURANCE AGAINST LEAKAGE .

Note: Steeple Tip will be reduced by approx. 14" when Adding Optional Cross

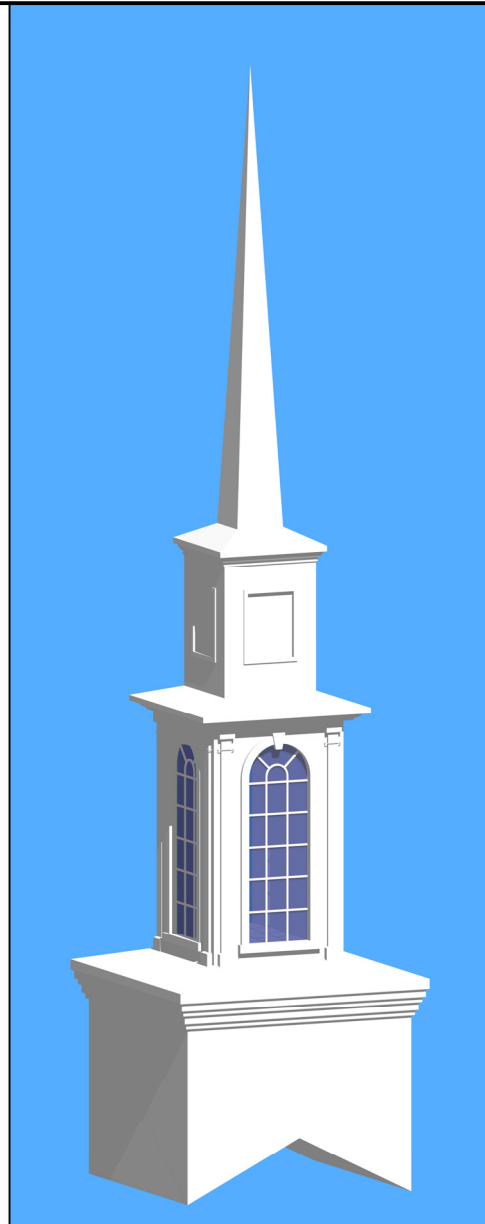

3-D VIEW

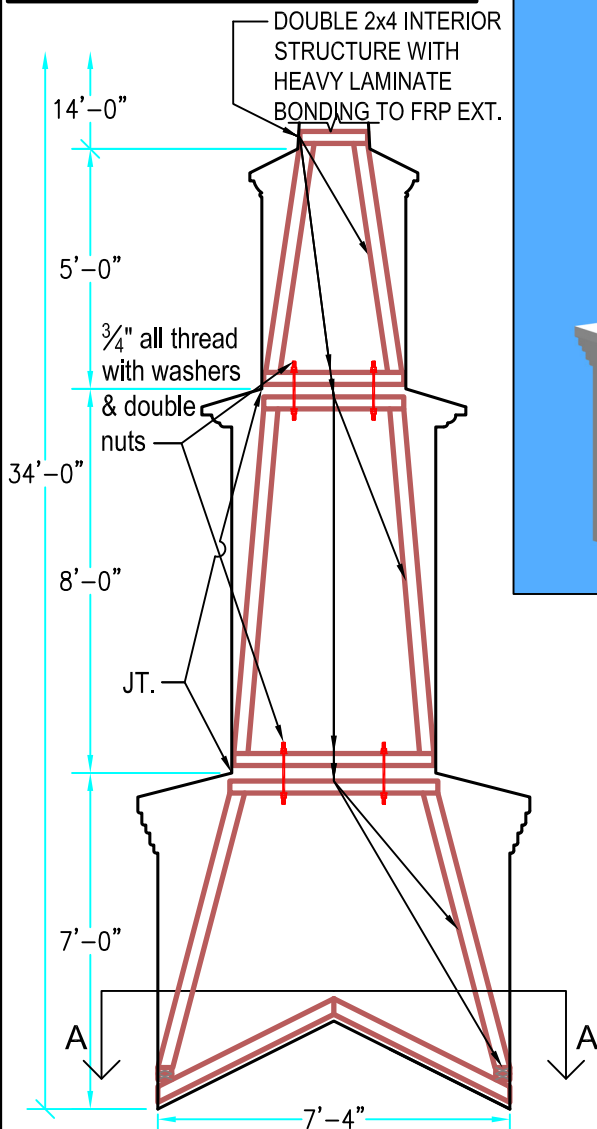

INTERIOR SUPPORT DETAIL

Scale: 1/4" = 1'-0"

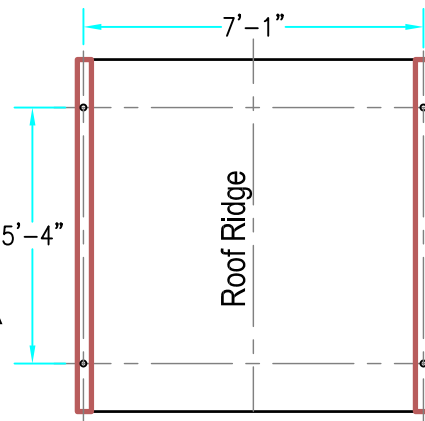

PLAN VIEW A-A

Scale: 1/4" = 1'-0"

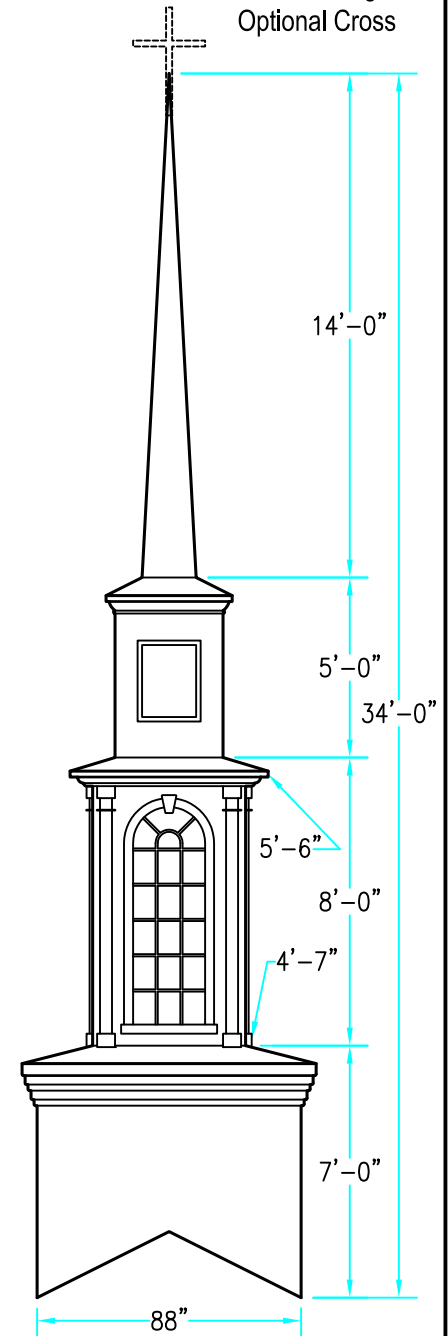

ELEVATION

Scale: 3/16" = 1'-0"

Drawings are property of Fiberglass Unlimited, Inc.; Dimensions may change slightly to accommodate manufacturing.

STEEPLES
Model # 525

FIBERGLASS UNLIMITED, INC.

Phone: 1-800-837-6211 Fax: 334-863-7975 Email: info@FiberG.com

183 Industrial Ave.
 Roanoke, Alabama 36274